

Dimension:
Unit=mm

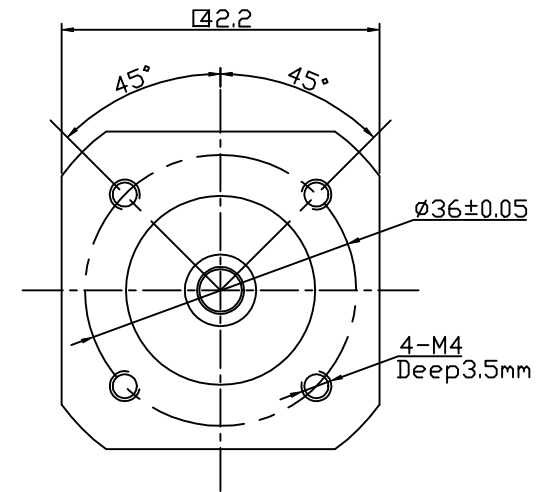
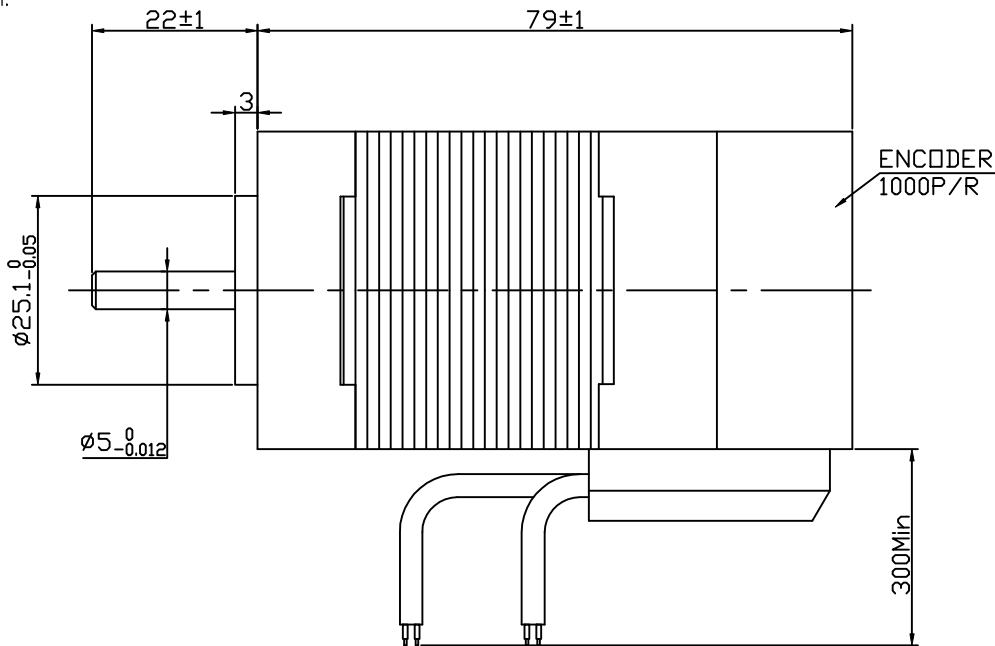

ROTATION: CW VIEWED FROM OUTPUT SHAFT

MANUFACTURER MODEL	JK42BLS02-X035ED
NUMBER OF POLES	8
PHASE TO PHASERESISTANCE	0.73 OHMS
NOMINAL VOLTAGE	24 VDC
NO LOAD SPEED	6500±10% RPM
NO LOAD CURRENT	0.45 Amps Max.
RATED TORQUE	0.143 N-m
RATED SPEED	4000±10% RPM
OUTPUT POWER	60 W
BACK EMF CONSTANT	4.1 V/kRPM
TORQUE CONSTANT	0.04 N-m/A
INSULATION CLASS	B

Encoder Wiring Diagram:

Vcc	Encoder Voltage(+5V)	RED 红
EGND	Encoder Grand(0V)	BLK 黑
EA	Encoder A phase input	GREEN 绿
EB	Encoder B phase input	BLUE 蓝
EZ	Encoder Z phase input	YELLOW 黄

ELECTRICAL CONNECTION TABLE

+5V	RED 红	UL1007 26 AWG
HALL U	YEL 黄	
HALL V	GRE 绿	
HALL W	BLU 蓝	
GND	GND 黑	UL1007 20 AWG
PHASE U	YEL 黄	
PHASE V	GRE 绿	
PHASE W	BLU 蓝	

Connection diagram:

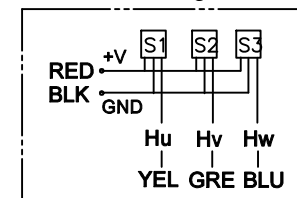

Hall sensor cable
Note: hall sensor power supply
voltage +5 to +20VDC

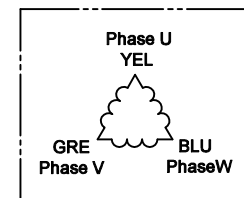

Wiring cable

REV. QTY. No. SIG. DATE				Title:		常州精控电机电器有限公司
DESIGN 张宇 21.03.06 STD.				Specification		
CHECK				CLS.MAK	WEIGHT	SCALE
PROC.				PAGE: 1/1		JK42BLS02-X035ED
						www.jkongmotor.com